

Owner's Manual

Operation & Care

INSTALLER: Leave this manual with party responsible for use and operation.

OWNER: Retain this manual for future reference.

Contact your dealer with questions on installation, operation, or service.

NOTICE: DO NOT DISCARD THIS MANUAL

QUADRA-FIRE®

CASTILE-B PELLET STOVE

Model(s):

CASTILE-MBK-B

CASTILE-CWL-B

CASTILE-CSB-B

CASTILE-PMH-B

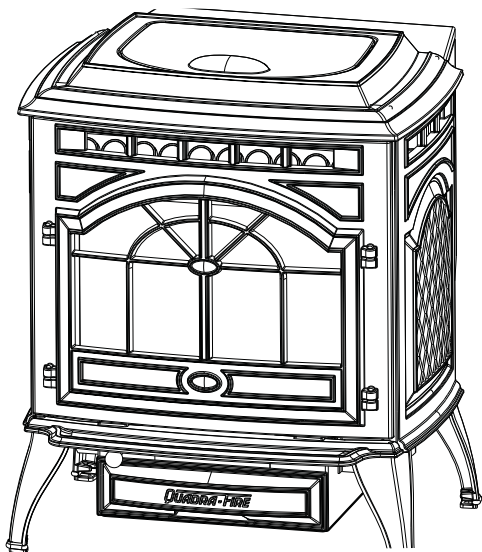

Tested and
Listed by  Portland
Oregon USA
OMNI-Test Laboratories, Inc.

CAUTION

Tested and approved for wood pellets and shelled corn only. Burning of any other type of fuel voids your warranty.

CAUTION

Check building codes prior to installation.

- Installation **MUST** comply with local, regional, state and national codes and regulations.
- Consult local building, fire officials or authorities having jurisdiction about restrictions, installation inspection, and permits.

⚠ WARNING



If the information in these instructions is not followed exactly, a fire could result causing property damage, personal injury, or death.

- Do not store or use gasoline or other flammable vapors and liquids in the vicinity of this or any other appliance.
- Do not overfire - If heater or chimney connector glows, you are overfiring. Overfiring will void your warranty.
- Comply with all minimum clearances to combustibles as specified. Failure to comply may cause house fire.

⚠ WARNING



HOT SURFACES!

Glass and other surfaces are hot during operation AND cool down.

Hot glass will cause burns.

- Do not touch glass until it is cooled
- NEVER allow children to touch glass
- Keep children away
- CAREFULLY SUPERVISE children in same room as fireplace.
- Alert children and adults to hazards of high temperatures
- **High temperatures may ignite clothing or other flammable materials.**
- Keep clothing, furniture, draperies and other flammable materials away.

NOTE

To obtain a French translation of this manual, please contact your dealer or visit www.quadrafire.com

Pour obtenir une traduction française de ce manuel, s'il vous plaît contacter votre revendeur ou visitez www.quadrafire.com

Congratulations

and Welcome to the Quadra-Fire Family!

A. Congratulations

Hearth & Home Technologies welcomes you to our tradition of excellence! In choosing a Quadra-Fire appliance, you have our assurance of commitment to quality, durability, and performance.

This commitment begins with our research of the market, including 'Voice of the Customer' contacts, ensuring we make products that will satisfy your needs. Our Research and Development facility then employs the world's most advanced technology to achieve the optimum opera-

tion of our stoves, inserts and fireplaces. And yet we are old-fashioned when it comes to craftsmanship. Each unit is meticulously fabricated and gold and nickel surfaces are hand-finished for lasting beauty and enjoyment. Our pledge to quality is completed as each model undergoes a quality control inspection.

We wish you and your family many years of enjoyment in the warmth and comfort of your hearth appliance. Thank you for choosing Quadra-Fire.

NOTE: Clearances may only be reduced by means approved by the regulatory authority having jurisdiction

B. Sample of Serial Number / Safety Label

LOCATION: Back of Stove

Test Lab &
Report No.

Model
Name

Serial No.

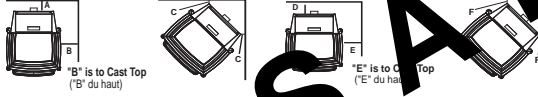
<p>Tested and Listed by  Portland Oregon USA OMNI-Test Laboratories, Inc. Report / Rapport 061-S-774-6.2</p> <p>QUADRA-FIRE</p> <p>Castile Pellet Stove</p> <p>SERIAL NO. / NUMERO DE SERIE 007</p>	<p>Appareil de chauffage autonome type de bouillottes. Accepté dans l'installation dans les maisons mobiles. Cet appareil a été testé et enregistré pour l'usage dans les Maisons Mobiles en accord avec OAR 814-23-9000 jusqu'à 814-23-909. OMNI-Test Laboratories, Inc. a déterminé que cet appareil se conforme avec la norme de l'Association Canadienne de normalisation (CSA) B415.1 ainsi que le Titre 40 du Code Fédéral de Régulations des États-Unis, partie 60, sous-partie AAA. Accréditations OMNI-Test Laboratories: Le Conseil Canadien des Normes (CCNSC), l'Institut des Standards Nationaux American (ANSI) et l'Agence de Protection Environnementale (EPA).</p> <p>Testé à: ASTM E1509-95, ULC S627-00, ULC/CORD-C1482-M1990 Room Heating Pellet Burning Type, (UM) 84-HUD FOR USE ONLY WITH PELLETED WOOD OR SHELLED FIELD CORN FUEL. Do not use any other type of fuel.</p> <p>Input Rating: 38,700 Btu/s/hr Electrical Rating: 115 VAC, 60 Hz, Start 4.1 Amps, Run 1.1 AMPS. Route power cord away from unit. Do not route cord under or in front of appliance. Do not obstruct the space beneath the heater.</p> <p>DANGER: Risk of electrical shock. Disconnect power supply before servicing. Replace glass only with 5mm ceramic available from your dealer. To start, set thermostat above room temperature, the stove will light automatically. To shutdown, set thermostat to below room temperature. For further instruction refer to owner's manual. Keep viewing and ash removal doors tightly closed during operation.</p> <p>PREVENT HOUSE FIRES</p> <p>Install and use only in accordance with manufacturer's installation and operating instructions. Contact local building or fire officials about restrictions and inspection in our area.</p> <p>WARNING - FOR MOBILE HOMES: Do not install appliance in a sleeping room. An outside combustion air inlet must be provided. The structural integrity of the mobile home floor, ceiling and walls must be maintained.</p> <p>Refer to manufacturer's instructions and local codes for precautions required for passing chimney through a comb wall or ceiling. Inspect and clean vent system frequently in accordance with manufacturer's instructions.</p> <p>DO NOT CONNECT THIS UNIT TO A CHIMNEY SERVING ANOTHER APPLIANCE. Use a 3" or 4" diameter type "L" or "PL" venting.</p>
<p>MINIMUM CLEARANCES TO COMBUSTIBLE MATERIALS</p>  <p>Note 1: In residential installations, when using Parts 811-0890, (3 in. - 3 in. Top Vent Adapter) and 812-3570 (3 in. - 6 in. Offset Adapter), 24 gauge 4" single wall flue connector may be used.</p> <p>Note 2: In residential installations, when using Parts 811-0890, (3 in. - 3 in. Top Vent Adapter) and 812-3570 (3 in. - 6 in. Offset Adapter), use listed double wall flue connector. An Outside Air Kit (Part 811-0872), must be used with manufactured home installation.</p> <p>Note 3: Pour l'installation dans les maisons préfabriquées, lorsque les pièces 811-0860, (dessus de l'adaptateur de ventilation 76mm - 76mm) et 812-3570 (le ressaut de l'adaptateur 76 mm-152mm), utilisez un tuyau connecteur enregistré pour mur double. Un assemblage d'air extérieur (pièce 811-0872), doit être utilisé pour l'installation dans les maisons préfabriquées.</p>	
<p>ETATS-UNIS - RECOMMANDE : CANADA - REQUIERRE</p> <p>The stove must be installed on a non-combustible surface. The stove must be installed on a non-combustible surface. The stove must be installed on a non-combustible surface.</p>	
<p>2015 2016 2017 JAN FEB MAR APR MAY JUNE JULY AUG SEPT OCT NOV DEC</p>	

 **CAUTION:** HOT WHILE IN OPERATION DO NOT TOUCH, KEEP CHILDREN, CLOTHING AND FURNITURE AWAY. CONTACT MAY CAUSE SKIN BURNS. SEE NAMEPLATE AND INSTRUCTIONS. Operate this unit only with fuel hopper lid closed. Failure to do so may result in emissions of products of combustion from the hopper under certain conditions. Maintain hopper seal in good condition. Do not over fill the hopper.

ATTENTION: CHAUD LORS DE L'OPERATION. NE PAS TOUCHER. GARDEZ LES ENFANTS ET LES VETEMENTS LOIN DE L'ESPACE DÉSIGNÉ DE L'INSTALLATION. LE CONTACT PEUT CAUSER DES BRÛLURES À LA PEAU. VOIR L'ÉTIQUETTE ET LES INSTRUCTIONS. Opérez cet appareil uniquement avec le couvercle de la trémie fermé. Le défaut de ne pas suivre les instructions peut résulter, sous certaines conditions, en une combustion des émissions des produits venant de la trémie. Ne pas remplir la trémie trop pleine.

7014-197C

QUADRA-FIRE

CASTILE PELLET STOVE



Mfg. Date



Certified to comply with July 1990 particulate emission standards.



DO NOT REMOVE THIS LABEL / NE PAS ENLEVER L'ÉTIQUETTE
 Made in U.S.A. of U.S. and imported parts.
 Fabriqué aux États-Unis-d'Amérique par des pièces d'origine américaine et pièces importées.

7021-1500



Safety Alert Key:

- **DANGER!** Indicates a hazardous situation which, if not avoided will result in death or serious injury.
- **WARNING!** Indicates a hazardous situation which, if not avoided could result in death or serious injury.
- **CAUTION!** Indicates a hazardous situation which, if not avoided, could result in minor or moderate injury.
- **NOTICE:** Indicates practices which may cause damage to the appliance or to property.

TABLE OF CONTENTS

A. Congratulations.....	2	4 Troubleshooting Guide.....	17
B. Sample of Serial Number / Safety Label.....	2	5 Service Parts Replacement.....	20
C. Warranty Policy	4	A. Glass Replacement - Door Assembly.....	20
1 Listing and Code Approvals	6	B. Igniter Replacement.....	20
A. Appliance Certification	6	C. Blower Replacement	21
B. BTU & Efficiency Specifications.....	6	D. Baffle & Brick Set Removal	22
C. Glass Specifications	6	6 Reference Materials	23
D. Electrical Rating.....	6	A. Component Functions	23
E. Mobile Home Approved	6	B. Component Locations.....	25
2 Operating Instructions	7	C. Exploded Drawings.....	26
A. Fire Safety	7	D. Service Parts	27
B. Non-Combustible Materials	7	E. Homeowner Notes	31
C. Combustible Materials	7		
D. Fuel Material and Fuel Storage	7		
E. General Operating Information	8		
F. Before Your First Fire	8		
G. Starting Your First Fire	8		
H. Fire Characteristics.....	9		
I. Feed Rate Adjustment Instructions	9		
J. Ignition Cycles.....	9		
K. Clear Space.....	10		
L. Frequently Asked Questions	11		
3 Maintenance and Service	12		
A. Proper Shutdown Procedure	12		
B. Quick Reference Maintenance Chart.....	12		
C. General Maintenance and Cleaning	13		
D. High Ash Fuel Content Maintenance	16		
E. Soot or Creosote Fire	16		

CASTILE FREESTANDING

C. Warranty Policy

Hearth & Home Technologies Inc. LIMITED LIFETIME WARRANTY

Hearth & Home Technologies Inc., on behalf of its hearth brands ("HHT"), extends the following warranty for HHT gas, wood, pellet, coal and electric hearth appliances that are purchased from an HHT authorized dealer.

WARRANTY COVERAGE:

HHT warrants to the original owner of the HHT appliance at the site of installation, and to any transferee taking ownership of the appliance at the site of installation within two years following the date of original purchase, that the HHT appliance will be free from defects in materials and workmanship at the time of manufacture. After installation, if covered components manufactured by HHT are found to be defective in materials or workmanship during the applicable warranty period, HHT will, at its option, repair or replace the covered components. HHT, at its own discretion, may fully discharge all of its obligations under such warranties by replacing the product itself or refunding the verified purchase price of the product itself. The maximum amount recoverable under this warranty is limited to the purchase price of the product. This warranty is subject to conditions, exclusions and limitations as described below.

WARRANTY PERIOD:

Warranty coverage begins on the date of original purchase. In the case of new home construction, warranty coverage begins on the date of first occupancy of the dwelling or six months after the sale of the product by an independent, authorized HHT dealer/ distributor, whichever occurs earlier. The warranty shall commence no later than 24 months following the date of product shipment from HHT, regardless of the installation or occupancy date. The warranty period for parts and labor for covered components is produced in the following table.

The term "Limited Lifetime" in the table below is defined as: 20 years from the beginning date of warranty coverage for gas appliances, and 10 years from the beginning date of warranty coverage for wood, pellet, and coal appliances. These time periods reflect the minimum expected useful lives of the designated components under normal operating conditions.

Warranty Period		HHT Manufactured Appliances and Venting							Components Covered
Parts	Labor	Gas	Wood	Pellet	EPA Wood	Coal	Electric	Venting	
1 Year		X	X	X	X	X	X	X	All parts and material except as covered by Conditions, Exclusions, and Limitations listed
2 years				X	X	X			Igniters, electronic components, and glass
		X	X	X	X	X			Factory-installed blowers
				X					Molded refractory panels
3 years				X					Firepots and burnpots
5 years	1 year			X	X				Castings and baffles
7 years	3 years		X	X	X				Manifold tubes, HHT chimney and termination
10 years	1 year	X							Burners, logs and refractory
Limited Lifetime	3 years	X	X	X	X	X			Firebox and heat exchanger
90 Days		X	X	X	X	X	X	X	All replacement parts beyond warranty period

See conditions, exclusions, and limitations on next page.

WARRANTY CONDITIONS:

- This warranty only covers HHT appliances that are purchased through an HHT authorized dealer or distributor. A list of HHT authorized dealers is available on the HHT branded websites.
- This warranty is only valid while the HHT appliance remains at the site of original installation.
- Contact your installing dealer for warranty service. If the installing dealer is unable to provide necessary parts, contact the nearest HHT authorized dealer or supplier. Additional service fees may apply if you are seeking warranty service from a dealer other than the dealer from whom you originally purchased the product.
- Check with your dealer in advance for any costs to you when arranging a warranty call. Travel and shipping charges for parts are not covered by this warranty.

WARRANTY EXCLUSIONS:

This warranty does not cover the following:

- Changes in surface finishes as a result of normal use. As a heating appliance, some changes in color of interior and exterior surface finishes may occur. This is not a flaw and is not covered under warranty.
- Damage to printed, plated, or enameled surfaces caused by fingerprints, accidents, misuse, scratches, melted items, or other external sources and residues left on the plated surfaces from the use of abrasive cleaners or polishes.
- Repair or replacement of parts that are subject to normal wear and tear during the warranty period. These parts include: paint, wood, pellet and coal gaskets, firebricks, grates, flame guides, light bulbs, batteries and the discoloration of glass.
- Minor expansion, contraction, or movement of certain parts causing noise. These conditions are normal and complaints related to this noise are not covered by this warranty.
- Damages resulting from: (1) failure to install, operate, or maintain the appliance in accordance with the installation instructions, operating instructions, and listing agent identification label furnished with the appliance; (2) failure to install the appliance in accordance with local building codes; (3) shipping or improper handling; (4) improper operation, abuse, misuse, continued operation with damaged, corroded or failed components, accident, or improperly/incorrectly performed repairs; (5) environmental conditions, inadequate ventilation, negative pressure, or drafting caused by tightly sealed constructions, insufficient make-up air supply, or handling devices such as exhaust fans or forced air furnaces or other such causes; (6) use of fuels other than those specified in the operating instructions; (7) installation or use of components not supplied with the appliance or any other components not expressly authorized and approved by HHT; (8) modification of the appliance not expressly authorized and approved by HHT in writing; and/or (9) interruptions or fluctuations of electrical power supply to the appliance.
- Non-HHT venting components, hearth components or other accessories used in conjunction with the appliance.
- Any part of a pre-existing fireplace system in which an insert or a decorative gas appliance is installed.
- HHT's obligation under this warranty does not extend to the appliance's capability to heat the desired space. Information is provided to assist the consumer and the dealer in selecting the proper appliance for the application. Consideration must be given to appliance location and configuration, environmental conditions, insulation and air tightness of the structure.

This warranty is void if:

- The appliance has been over-fired or operated in atmospheres contaminated by chlorine, fluorine, or other damaging chemicals. Over-firing can be identified by, but not limited to, warped plates or tubes, rust colored cast iron, bubbling, cracking and discoloration of steel or enamel finishes.
- The appliance is subjected to prolonged periods of dampness or condensation.
- There is any damage to the appliance or other components due to water or weather damage which is the result of, but not limited to, improper chimney or venting installation.

LIMITATIONS OF LIABILITY:

- The owner's exclusive remedy and HHT's sole obligation under this warranty, under any other warranty, express or implied, or in contract, tort or otherwise, shall be limited to replacement, repair, or refund, as specified above. In no event will HHT be liable for any incidental or consequential damages caused by defects in the appliance. Some states do not allow exclusions or limitation of incidental or consequential damages, so these limitations may not apply to you. This warranty gives you specific rights; you may also have other rights, which vary from state to state. EXCEPT TO THE EXTENT PROVIDED BY LAW, HHT MAKES NO EXPRESS WARRANTIES OTHER THAN THE WARRANTY SPECIFIED HEREIN. THE DURATION OF ANY IMPLIED WARRANTY IS LIMITED TO DURATION OF THE EXPRESSED WARRANTY SPECIFIED ABOVE.

1 Listing and Code Approvals

A. Appliance Certification

Model	Castile Pellet Stove
Laboratory	OMNI Test Laboratories, Inc.
Report No.	061-S-77d-6.2
Type	Solid Fuel Room Heater/Pellet Fuel Burning Type
Standard	ASTM E1509-04, ULC S627-00 and ULC/ORD-C1482-M1990 Room Heater Pellet Fuel Burning type and (UM) 84-HUD, Mobile Home Approved.
FCC	Complies with Part 15 of FCC Rules. Operation is subject to the following two conditions: (1) this device may not cause harmful interference, and (2) this device must accept any interference received, including interference that may cause undesired operation.

NOTICE: This installation must conform with local codes. In the absence of local codes you must comply with the **ASTM E1509-04, ULC S627-00, (UM) 84-HUD and ULC/ORD-C-1482.**

The Quadra-Fire Castile Pellet Heater meets the U.S. Environmental Protection Agency's emission limits for pellet heaters sold after May 15, 2015.

This pellet heater needs periodic inspection and repair for proper operation. It is against federal regulations to operate this pellet heater in a manner inconsistent with operating instructions in this manual.

B. BTU & Efficiency Specifications

EPA Certification #:	940-14
EPA Certified Emissions:	1.8 grams per hour
*LHV Tested Efficiency:	N/A
**HHV Tested Efficiency:	N/A
***EPA BTU Output:	8,500 to 28,200 / hr.
****BTU Input:	11,600 to 38,700 / hr.
Vent Size:	3 or 4 inches, L or PL
Hopper Capacity:	40 lbs. +/- 5 lbs.
Fuel	Wood Pellets
* Weighted average LHV efficiency using data collected during EPA emissions test.	
**Weighted average HHV efficiency using data collected during EPA emissions test.	
***A range of BTU outputs based on EPA Default Efficiency and the burn rates from the low and high EPA tests.	
****Based on the maximum feed rate per hour multiplied by approximately 8600 BTU's which is the average BTU's from a pound of pellets.	

C. Glass Specifications

This stove is equipped with 5mm ceramic glass. Replace glass only with 5mm ceramic glass. Please contact your dealer for replacement glass.

D. Electrical Rating

115 VAC, 60 Hz, Start 5 Amps, Run 1.25 Amps

E. Mobile Home Approved

- This appliance is approved for mobile home installations when not installed in a sleeping room and when an outside combustion air inlet is provided.
- The structural integrity of the mobile home floor, ceiling, and walls must be maintained.
- The appliance must be properly grounded to the frame of the mobile home and use only Listed pellet vent Class "L" or "PL" connector pipe.
- Outside Air Kit, part OAK-ACC must be installed in a mobile home installation.

WARNING



Fire Risk.

Hearth & Home Technologies disclaims any responsibility for, and the warranty will be voided by, the following actions:

- Installation and use of any damaged appliance.
- Modification of the appliance.
- Installation other than as instructed by Hearth & Home Technologies.
- Installation and/or use of any component part not approved by Hearth & Home Technologies.
- Operating appliance without fully assembling all components.
- Operating appliance without legs attached (if supplied with unit).
- Do NOT Overfire - If appliance or chimney connector glows, you are overfiring.

Any such action that may cause a fire hazard.

Improper installation, adjustment, alteration, service or maintenance can cause injury or property damage.



For assistance or additional information, consult a qualified installer, service agency or your dealer.

NOTE: Hearth & Home Technologies, manufacturer of this appliance, reserves the right to alter its products, their specifications and/or price without notice.

Quadra-Fire is a registered trademark of Hearth & Home Technologies.

User Guide

2 Operating Instructions

 WARNING	
	<p>Fire Risk.</p> <ul style="list-style-type: none"> Do not operate appliance before reading and understanding operating instructions. Failure to operate appliance properly may cause a house fire.

A. Fire Safety

To provide reasonable fire safety, the following should be given serious consideration:

- Install at least one smoke detector and CO monitor on each floor of your home.
- Locate detectors away from the heating appliance and close to the sleeping areas.
- Follow the detector's manufacturer's placement and installation instructions and maintain regularly.
- Conveniently locate a Class A fire extinguisher to contend with small fires.
- In the event of a hopper fire:
 - Evacuate the house immediately.
 - Notify fire department.

B. Non-Combustible Materials

Material which will not ignite and burn, composed of any combination of the following:

- | | | | |
|---------|-----------|---------|------------|
| - Steel | - Plaster | - Glass | - Tile |
| - Brick | - Iron | - Slate | - Concrete |

Materials reported as passing **ASTM E 136, Standard Test Method for Behavior of Metals, in a Vertical Tube Furnace of 750° C.**

C. Combustible Materials

Material made of/or surfaced with any of the following materials:

- | | | |
|------------------------|-----------|----------------|
| - Compressed Paper | - Wood | - Plywood/OSB |
| - Sheet Rock (drywall) | - Plastic | - Plant Fibers |

Any material that can ignite and burn: flame proofed or not, plastered or un-plastered.

D. Fuel Material and Fuel Storage

Pellet fuel quality can greatly fluctuate. This appliance has been designed to burn a wide variety of fuels, giving you the choice to use the fuel that is most economical in your region.

Hearth & Home Technologies strongly recommends only using Pellet Fuel Institute (PFI) certified fuel.

Fuel Material

- Made from sawdust or wood by-products
- Depending on the source material it may have a high or low ash content.

Higher Ash Content Material

- Hardwoods with a high mineral content
- Fuel that contains bark
- Standard grade pellets, high ash pellets,

Lower Ash Content Material

- Softwoods
- Fuels with low mineral content
- Premium grade pellets

Lower Ash Content Material

- Moisture content must be 15% or less
- Corn must be free of debris. Never burn corn straight from the field. It will clog the auger mechanism.
- Corn with excessive grain dust must be screened by sifting with 3/16 (4.76mm) inch mesh screening
- Do not sue corn that contains additives such as oils or means or has been chemically treated with pesticides. It will void your warranty and destroy the exhaust system.

 CAUTION!	
Do not burn fuel that contains an additive; (such as soybean oil).	
<ul style="list-style-type: none"> May cause hopper fires Damage to product may result 	
Read the ingredients list on the package.	

Clinkers

Minerals and other non-combustible materials such as sand will turn into a hard, glass-like substance called a clinker when heated in the firepot.

Trees from different areas will vary in mineral content. That is why some fuels produce more clinkers than others.

Moisture

Always burn dry fuel. Burning fuel with high moisture content takes heat from the fuel and tends to cool the appliance, robbing heat from your home. Damp pellet fuel can clog the feed system.

Size

- Pellets are either 1/4 inch or 5/16 inch (6-8mm) in diameter
- Length should be no more than 1-1/2 inches (38mm)
- Pellet lengths can vary from lot to lot from the same manufacturer
- Due to length variations, the flame height (feed rate) may need adjusting occasionally. See **page 9** for instructions.

CASTILE FREESTANDING

Performance

- Higher ash content requires the ash drawer to be emptied more frequently
- Hardwoods require more air to burn properly
- Premium wood pellets produce the highest heat output.
- Burning pellets longer than 1-1/2 inches (38mm) can cause an inconsistent fuel feed rate and/or missed ignitions.

We recommend that you buy fuel in multi-ton lots whenever possible. However, we do recommend trying various brands before purchasing multi-ton lots to ensure your satisfaction.

Changing to Different Fuel Type

- Empty the hopper of the previous fuel
 - Thoroughly vacuum hopper before filling with the new fuel
- The burn rate, BTU content and heat output will all vary depending on the fuel selected.

Storage

- Wood pellets should be left in their original sealed bag until using to prevent moisture absorption.
- This will also prevent rodents from becoming a problem.
- Do not store any pellet fuel within the clearance requirements or in an area that would hinder routine cleaning and maintenance.

E. General Operating Information

1. Thermostat Calls For Heat

The appliance is like most modern furnaces; when the thermostat calls for heat, your appliance will automatically light and deliver heat. When the room is up to temperature and the thermostat is satisfied, the red call light will go off and the appliance will shut down.

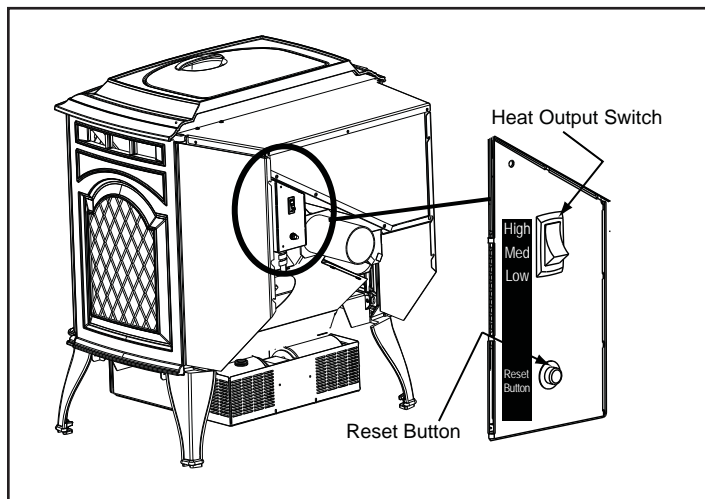

Figure 8.1

CAUTION

Tested and approved for wood pellets and shelled corn. Burning of any other type of fuel voids your warranty.

2. Heat Output Controls

This appliance is equipped with a heat output control switch that has three settings or burn rates; low, medium and high. The appliance will turn on and off as the thermostat demands. When the thermostat calls for heat, the appliance will start up at the burn rate for which it is set. If the appliance is set at one of the lower settings, it will run quieter but take longer to heat up an area than if it were set at a higher burn rate. Regardless of the burn rate, when the area is warm enough to satisfy the thermostat, the appliance will shut off.

F. Before Your First Fire

1. First, make sure your appliance has been properly installed and that all safety requirements have been met. Pay particular attention to the fire protection, venting and thermostat installation instructions.
2. Double check that the ash drawer and firebox are empty!
3. Close the front door.

IMPORTANT DETAIL: The tip of the thermocouple must be in contact with the inside end of the thermocouple cover or missed ignitions can occur.

G. Starting Your First Fire

1. A thermostat is required for proper operation of this appliance, except for corn. At this time, fill the hopper with pellets, set the thermostat to its lowest setting. Plug the power cord into nearby outlet.
2. The exhaust blower will stay on for approximately 18 minutes even though the thermostat is not calling for heat. This is normal.
3. Locate the heat output control switch mounted on the back of the appliance in the upper right corner. **Figure 8.1.** Turn it to the "high" setting by pushing the top of the control switch in and then adjust the thermostat to its highest setting. Remove the right side panel and the red call light located to the left of the control box will be on. **Figure 9.2.** This indicates the thermostat is calling for heat.
4. The fuel feed system and the igniter should now be on.
5. For your first fire it will be necessary to press the reset button once approximately 2 minutes after start up and again in 5 minutes. This will fill the feed system and allow the appliance to begin dropping pellets. The appliance will continue to run as long as the thermostat is calling for heat.
6. Once the appliance has ignited, let it burn for approximately 15 minutes, then set the thermostat to the desired room temperature. Adjust the heat output control switch to the desired setting.

NOTE: We recommend the use of a 50-50 blend of corn and wood pellets. The only change in operation is that the feed rate may require a slight adjustment. If the appliance is running all of the time, 100% corn will work after the fire has been started using wood pellets.

H. Fire Characteristics

A properly adjusted fire with the heat output control switch set on “high” has a short active flame pattern that extends out of the firepot approximately 4 inches (102mm). If the fire has tall flames with black tails and seems somewhat lazy, the feed rate will need to be reduced. This is done by sliding the fuel adjustment control rod down, which will reduce the feed. If the fire is not 4 inches (102mm) tall, slide the fuel adjustment control rod up to increase the feed. A medium and low setting will give a shorter flame. The flame will rise and fall somewhat. This is normal.

I. Feed Rate Adjustment Instructions

The feed adjustment control rod is factory set, and should be adequate for most fuels. However, if the flame height is too high or too low, you will need to adjust the feed rate. Wait until the appliance has been burning for 15 minutes before making your adjustments and allow 15 minutes for feed adjustment to take effect.

1. Loosen the set screw 1/4 to 1/2 turn during set-up of appliance. This will allow movement of the feed adjustment control rod. Do not re-tighten set screw. **Figure 9.1**
2. Loosen the wing nut.
3. Adjust the feed adjustment control rod upward towards the “+” symbol to increase the feed rate and flame height or down towards the “-” symbol, to decrease the feed rate and flame height.
4. Re-tighten the wing nut.

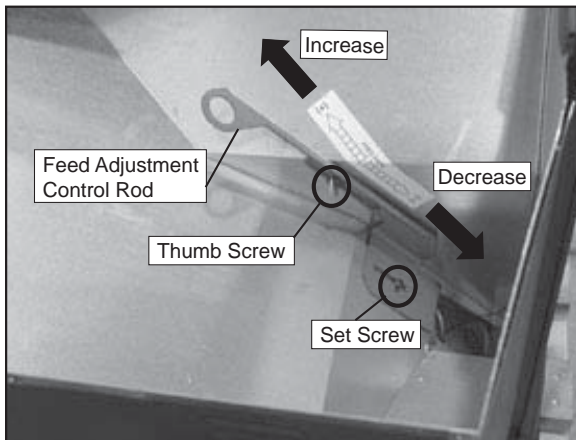

Figure 9.1

J. Ignition Cycles

1. At the beginning of each ignition cycle, it is normal to see some smoke in the firebox. The smoke will stop once the fire starts.
2. The convection blower will automatically turn on after your appliance has been burning for approximately 10 minutes. This blower transfers heat from your appliance into the room, and will continue to run after the thermostat has stopped calling for heat until the appliance has cooled down.

3. Occasionally the appliance may run out of fuel and shut itself down. When this happens, the red call light will be on. **See Figure 9.2.** To restart it, fill the hopper and press the reset button. **See Figure 8.1, page 8.** When you press the reset button the red call light will go out. Release the button and the light will come back on. You should see a fire shortly. If not, follow the instructions on **page 8**, of “Starting Your First Fire”.

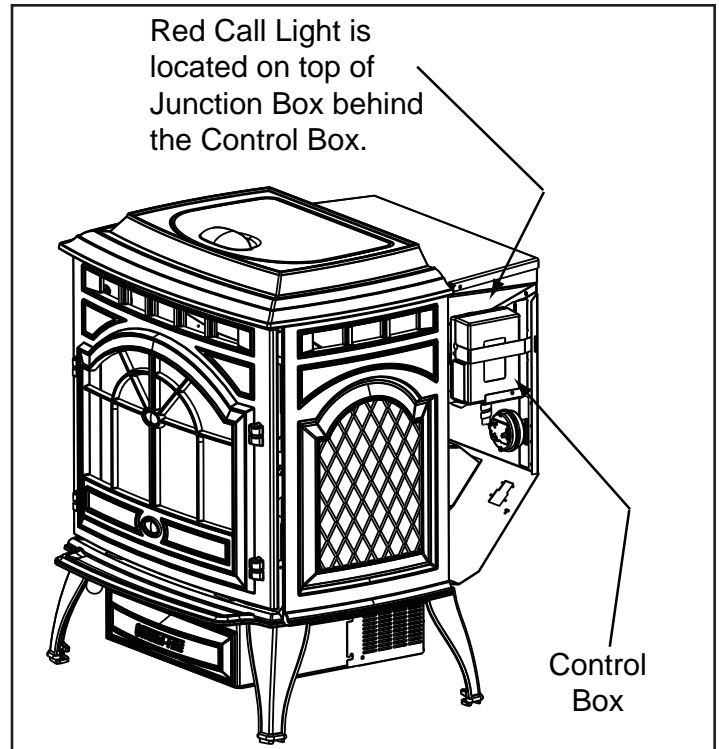

Figure 9.2

WARNING	
	<p>Fire Risk Do NOT operate appliance:</p> <ul style="list-style-type: none"> • With appliance door open. • Firepot floor open. • Cleaning slide plates open. <p>Do NOT store fuel:</p> <ul style="list-style-type: none"> • Closer than required clearances to combustibles to appliance • Within space required for loading or ash removal.

CAUTION	
HOT WHILE IN OPERATION. KEEP CHILDREN, CLOTHING AND FURNITURE AWAY. CONTACT MAY CAUSE SKIN BURNS.	

CASTILE FREESTANDING

K. Clear Space

Mantel: Avoid placing candles and other heat-sensitive objects on mantel or hearth. Heat may damage these objects.

NOTICE: Clearances may only be reduced by means approved by the regulatory authority having jurisdiction.



WARNING



Fire Risk.

Do NOT place combustible objects in front of the appliance. High temperatures may ignite clothing, furniture or draperies. Maintain a minimum clearance of 3 feet (914mm) in front of appliance.



WARNING



Fire Risk.

Keep combustible materials, gasoline and other flammable vapors and liquids clear of appliance.

- Do NOT store flammable materials in the appliance's vicinity.
- **DO NOT USE GASOLINE, LANTERN FUEL, KEROSENE, CHARCOAL LIGHTER FLUID OR SIMILAR LIQUIDS TO START OR "FRESHEN UP" A FIRE IN THIS HEATER.**
- **DO NOT BURN GARBAGE OR FLAMMABLE FLUIDS SUCH AS GASOLINE, NAPHTHA OR ENGINE OIL.**
- **DO NOT USE CHEMICALS OR FLUIDS TO START THE FIRE.**
- Keep all such liquids well away from the heater while it is in use.
- Combustible materials may ignite.



WARNING



Fire Risk

Do NOT operate appliance:

- With appliance door open.
- With firepot floor open.

Do NOT store fuel:

- Closer than required clearances to combustibles to appliance.
- Within space required for loading or ash removal.

L. Frequently Asked Questions

ISSUES	SOLUTIONS
1. Metallic noise.	1. Noise is caused by metal expanding and contracting as it heats up and cools down, similar to the sound produced by a furnace or heating duct. This noise does not affect the operation or longevity of your appliance.
2. Ash buildup on glass.	2. This is normal. Clean the glass.
3. Glass has turned dirty.	3. Excessive build up of ash. The lower burn settings will produce more ash, the higher burn settings produce less. The more it burns on low the more frequent cleaning of the glass is required.
4. Fire has tall flames with black tails and is lazy.	4. The feed rate needs to be reduced or the firepot needs cleaning. Heat exchanger or exhaust blower needs cleaning.
5. Smokey start-up or puffs of smoke from the airwash.	5. Either the firepot is dirty or there is too much fuel at start-up and not enough air. Close down feed rate 1/4 inch at a time until this no longer happens.
6. Large flame at start-up.	6. This is normal. Flame will settle down once the fire is established.

CONTACT YOUR DEALER for additional information regarding operation and troubleshooting.
 Visit www.quadrafire.com to find a dealer.

CAUTION
<p>Odors and vapors released during initial operation.</p> <ul style="list-style-type: none"> • Curing of high temperature paint. • Open windows for air circulation. <p>Odors may be irritating to sensitive individuals.</p>



3 Maintenance and Service

When properly maintained, your fireplace will give you many years of trouble-free service. Contact your dealer to answer question regarding proper operation, troubleshooting and service for your appliance. Visit www.quadrafire.com to find a dealer. We recommend annual service by a qualified service technician.

A. Proper Shutdown Procedure

Turn thermostat all the way to the left. Unit will go into shutdown.

Follow the detailed instructions found in this section for each step listed in the chart below.

 CAUTION	
	Shock and Smoke Hazard
	<ul style="list-style-type: none"> • Turn down thermostat, let appliance completely cool and exhaust blower must be off. Now you can unplug appliance before servicing. • Smoke spillage into room can occur if appliance is not cool before unplugging. • Risk of shock if appliance not unplugged before servicing appliance.

This pellet heater has a manufacturer-set minimum low burn rate that must not be altered. It is against federal regulations to alter this setting or otherwise operate this pellet heater in a manner inconsistent with operating instructions in this manual.

B. Quick Reference Maintenance Chart

Cleaning or Inspection	Frequency		Daily	Weekly	Every 2 Weeks	Monthly	Yearly
Ash Pan - Burning Wood Pellets	Every 5 bags of fuel	OR		X			
Ash Pan - Burning Alternate Fuels	Every 1 bag of fuel	OR	X				
Ash Removal from Firebox	More frequently depending on the fuel type or ash build-up	OR		X			
Auto-Clean Inspection	More frequently depending on the fuel type	OR				X	
Blower, Combustion (Exhaust)	More frequently depending on the fuel type	OR					X
Blower, Convection	More frequently depending on the operating environment	OR					X
Door Latch Inspection	Prior to heating season	OR				X	
Firebox - Prepare for Non-Burn Season	At end of heating season	OR					X
Firepot - Burning Softwood Pellets	Every 5 bags	OR		X			
Firepot - Burning Hardwood Pellets	Every 3 bags	OR		X			
Firepot - Burning Alternate Fuels	Every 1 bag	OR	X				
Glass	When clear view of firepot becomes obscured	OR		X			
Heat Exchanger & Drop Tube	Every 1 ton of fuel	OR			X		
Hopper	Every 1 ton of fuel or when changing fuel types	OR				X	
Venting System	More frequently depending on the fuel type	OR					X

NOTICE: These are recommendations. Clean more frequently if you encounter heavy build-up of ash at the recommended interval or you see soot coming from the vent. Not properly cleaning your appliance on a regular basis will void your warranty.

C. General Maintenance and Cleaning

1. Types of Fuel

Depending on the type of fuel you are burning will dictate how often you have to clean your firepot.

If the fuel you are burning has a high dirt or ash content or you are burning shelled field corn, it may be necessary to clean the firepot more than once a day.

Dirty fuel will cause clinkers to form in the firepot. A clinker is formed when dirt, ash or a non-burnable substance is heated to 2000°F (1093°C) and becomes glass-like. See **page 16** in this section for more details on fuels with high ash content.

2. Cleaning Firepot with Cleaning Rod & Firepot Scraper

- **Frequency:** Daily or more often as needed
 - **By:** Homeowner
- a. The appliance must be in complete shutdown and cool and the exhaust blower off. If you are just cleaning the firepot, there is no need to unplug the appliance.
 - b. Pull firepot cleaning rod OUT a couple of times to help shake debris loose. If rod is hard to pull, it may be necessary to use your firepot clean-out tool to chip away material that has built up on the bottom plate of the firepot and to push out any clinkers. Larger clinkers may have to be removed from the top of the firepot. Corn clinkers can be especially difficult to break up.
 - c. The firepot floor plate must be fully closed when finished. **Figure 13.1.**

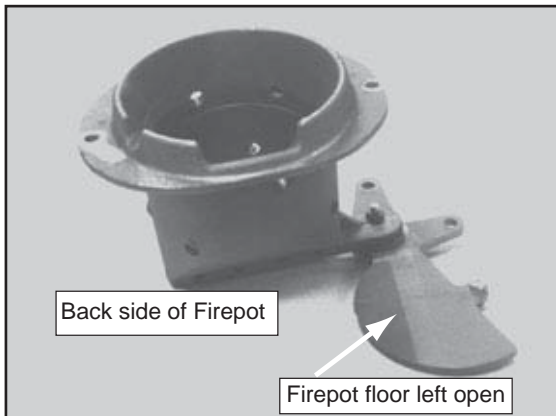

Figure 13.1

3. Ash Removal from Firebox

- **Frequency:** Every 5 bags or weekly or more frequently depending on ash build-up.
 - **By:** Homeowner
- a. There must not be any hot ashes in the firebox during cleaning so allow the appliance to completely cool. The firebox ash should be removed every time the exhaust path is cleaned. Frequent cleaning of the ash in the firebox will help slow down the build-up of ash in the exhaust blower and vent system.
 - b. Plug in your appliance, if unplugged, and turn the thermostat on and immediately shut it off to start the exhaust blower on its cycle time. It will pull fly ash out the exhaust instead of into the room.
 - c. Open cast hinged face. Directly underneath the firebox door and to the left and right of the firepot are 2 cleaning slide plates with finger holes. Pull both slide plates out and then open the glass door. Sweep the remaining ash from the firebox into the 2 open holes. A paint brush works well for this. Close slide plates.
 - d. This ash is deposited in the same ash pan as the firepot debris. The ash pan should be emptied every time you clean the firebox. Remember to place the ash and debris into a metal or noncombustible container.
 - e. The 2 cleaning slide plates must be fully closed when cleaning is complete. **See Disposal of Ashes.**



4. Cleaning Ash Pan



- **Frequency:** Weekly or every 5 bags of fuel
 - **By:** Homeowner
- Locate the ash pan underneath the firepot. Open the bottom ash door and slide the ash pan straight out. Empty into a non-combustible container and re-install ash pan. **See Disposal of Ashes.**

5. Disposal of Ashes

- **Frequency:** As needed
 - **By:** Homeowner
- Ashes should be placed in a steel container with a tight-fitting lid. The container of ashes should be moved outdoors immediately and placed on a non-combustible floor or on the ground, well away from all combustible materials, pending final disposal.

If the ashes are disposed of by burial in soil or otherwise locally dispersed, they should be retained in the closed container until all cinders have thoroughly cooled. Other waste shall not be placed in this container.

 WARNING	
	<p>Fire Risk</p> <ul style="list-style-type: none"> • NEVER pull firepot cleaning rod or cleaning slide plates out when appliance is operating. • The cleaning slide plates must be fully CLOSED when appliance is operating. • Hot pellets may fall into ashpan and start a fire or mis-starts due to lack of vacuum.

 WARNING	
	<p>Disposal of Ashes</p> <ul style="list-style-type: none"> • Ashes should be placed in metal container with tight fitting lid. • Ashes should be retained in closed container until all cinders have thoroughly cooled.

CASTILE FREESTANDING

6. Cleaning Heat Exchanger Chambers & Drop Tube

- **Frequency:** Monthly or every 1 ton of fuel
- **By:** Homeowner

The amount of ash buildup in the firepot will be a good guide to determine how often you should clean the heat exchangers.

- Allow the appliance to completely cool down before pulling the cleaning rods. Turn the thermostat on and then immediately off to start the exhaust blower on its cycle time. It will pull fly ash out the exhaust instead of into the room. Open the cast hinged face to access the 2 cleaning rods.
- Locate the 2 exposed rods directly underneath the heat exchanger tubes. **Figure 14.1.**
- To clean, pull the rods straight out until it stops, approximately 8 inches (203mm). Slide the rods OUT and IN a couple of times.

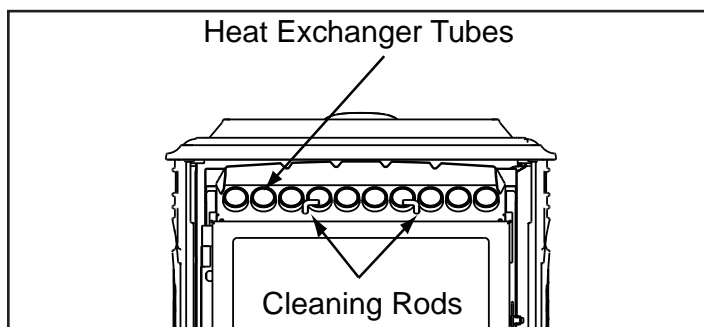

Figure 14.1

7. Cleaning Beneath Heat Exchanger

- **Frequency:** Monthly or after burning 1 ton of fuel
 - **By:** Homeowner
- Be sure the appliance is allowed to cool, has been unplugged and the exhaust blower is off
 - A more thorough cleaning is needed to remove the excess ash that is left behind from the use of the cleaning rods for the heat exchanger tubes.
 - The ash will be resting on the back of the baffle. This will require removing the cast baffle. Please refer to **page 22** for a detailed explanation of removing the baffle.

8. Cleaning the Exhaust Path

- **Frequency:** Every 25 bags or monthly or more frequently depending on ash build-up.
 - **By:** Homeowner
- Appliance must be completely cool.
 - Open cast hinge face. Remove baffle and right brick and thoroughly vacuum the area and continue throughout the rest of the firebox.
 - Replace right brick and baffle and close cast hinge face.

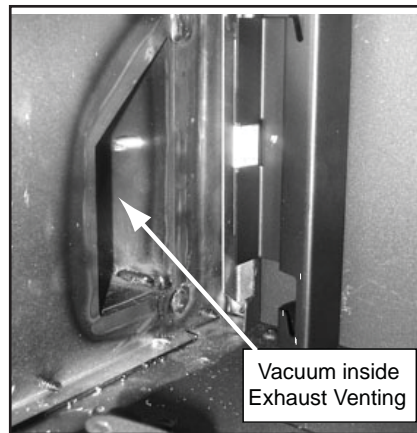

Figure 14.2

9. Cleaning the Hopper

- **Frequency:** Monthly or after burning 50 bags of fuel or when changing fuel type
- **By:** Homeowner

After burning approximately 1 ton of fuel you will need to clean the hopper to prevent sawdust build-up.

A combination of sawdust and pellets on the auger reduces the amount of fuel supply to the firepot. This can result in nuisance shutdowns and mis-starts.

- The appliance must be in complete shutdown. Allow the appliance to completely cool down.
- Empty the hopper of any remaining pellets.
- Vacuum the hopper and feed tube.

NOTE: Hearth & Home Technologies recommends to use a heavy duty vacuum cleaners specifically designed for solid fuel appliance cleaning.

10. Soot and Fly Ash: Formation & Need for Removal in Exhaust Venting System.

- **Frequency:** Yearly or more frequently depending on ash build-up.
- **By:** Qualified Service Technician/Homeowner

Be sure the appliance is allowed to cool, has been unplugged and the exhaust blower is off.

The products of combustion will contain small particles of fly ash. The fly ash will collect in the exhaust venting system and restrict the flow of the flue gases.

At start-up if there is incomplete combustion, or if there is a shutdown or incorrect operation of the appliance it will lead to some soot formation. This will collect in the exhaust venting system.

The venting (chimney) system may need to be cleaned at least once a year or more often depending upon the quality of your fuel or if there is a lot of horizontal pipe sections. Ash will build up more quickly in the horizontal sections.

11. Cleaning the Glass

- **Frequency:** When clear view of the firepot becomes obscure
- **By:** Homeowner
 - a. Appliance must be completely cool before cleaning glass.
 - b. Vacuum fly ash from glass and door rope.
 - c. Use a damp paper towel or any non-abrasive glass cleaner. Wipe off with dry towel.

CAUTION

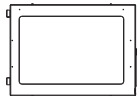

Handle glass assembly with care.

When cleaning glass:

- Avoid striking, scratching or slamming glass.
- Do NOT clean glass when hot.
- Do NOT use abrasive cleaners.
- Refer to maintenance instructions.



WARNING

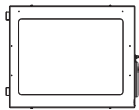

Handle glass with care.

- Inspect the gasket to ensure it is undamaged.
- Do NOT strike, slam or scratch glass.
- Do NOT operate appliance with glass assembly removed.

- Do NOT operate with glass cracked, broken or scratched.

12. Door Latch Inspection

- **Frequency:** Prior to heating season
- **By:** Homeowner

The door latch is non-adjustable but the gasketing between the glass and firebox should be inspected periodically to make sure there is a good seal.

13. Cleaning Exhaust Blower - Requires No Lubrication

- **Frequency:** Yearly or as needed
- **By:** Qualified Service Technician
- **Task:** Contact your local dealer

14. Cleaning Convection Blower - Requires No Lubrication

- **Frequency:** Yearly or as needed
- **By:** Qualified Service Technician / Homeowner

The convection blower is located at the bottom rear of the stove. It is housed inside the screen box. See **page 21** for detailed instructions on removing the blower.

The blower has two impellers, one on each side of the motor. They should be cleaned at least once each year or more often as needed.

15. Cleaning the Top Vent Adapter

- a. The appliance must be in complete shutdown and the exhaust blower should be off. Allow the appliance to completely cool down.
- b. Open the clean out cover. **See Figure 15.1.**
- c. Sweep out any ash build-up.

NOTE: There are heavy duty vacuum cleaners specifically designed for solid fuel appliance cleaning.

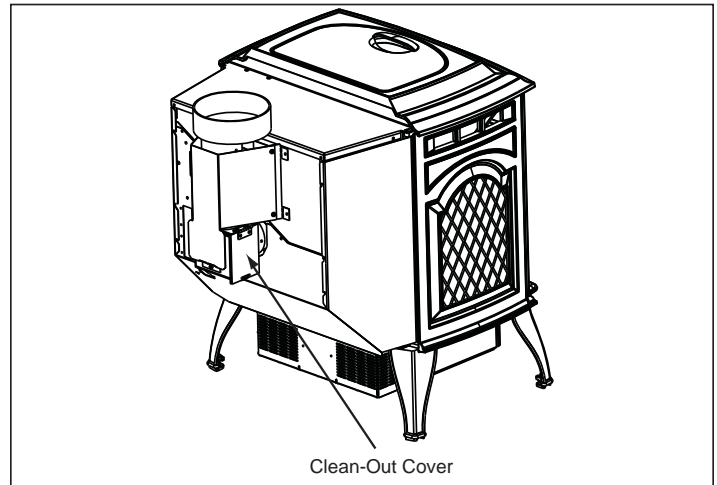

Figure 15.1

16. Preparing Firebox for Non-Burn Season

- **Frequency:** Yearly at the end of the heating season
- **By:** Homeowner
 - a. Be sure the appliance is allowed to cool, has been unplugged and the exhaust blower is off.
 - b. Remove all ash from the firebox and vacuum thoroughly.
 - c. Paint all exposed steel, including cast-iron.
 - Use the Touch-Up paint supplied with the appliance; or;
 - Purchase paint from your local dealer.
 - Must use a high-temperature paint made specifically for heating appliances.

D. High Ash Fuel Content Maintenance

- **Frequency:** As needed
- **By:** Homeowner

Poor quality pellet fuel, or lack of maintenance, can create conditions that make the firepot fill quickly with ashes and clinkers.

This condition makes the appliance susceptible to overfilling the firepot with pellets which may result in smoking, sooting and possible hopper fires. **Figure 16.1** shows an example where the firepot overfills, pellets back up into the feed tube and ash has accumulated in the firebox.

An inefficient and non-economical method of burning of fuel caused by poor quality pellet fuel is shown in **Figure 16.2**.

The correct flame size when good quality, premium pellet fuel is burned is shown in **Figure 16.3**.

If the ash buildup exceeds the half way point in the firepot **IMMEDIATE ATTENTION AND CLEANING IS REQUIRED.**

E. Soot or Creosote Fire

Establish a routine for the fuel, wood burner and firing technique. Check daily for creosote build-up until experience shows how often you need to clean to be safe. Be aware that the hotter the fire the less creosote is deposited, and weekly cleaning may be necessary in the mild weather even though monthly cleaning may be enough in the coldest months. Contact your local municipal or provincial fire authority for information on how to handle a chimney fire.

In the event of a soot or creosote fire, close the firebox door, exit the building immediately and contact the proper fire authorities.

DO NOT under any circumstances re-enter the building.

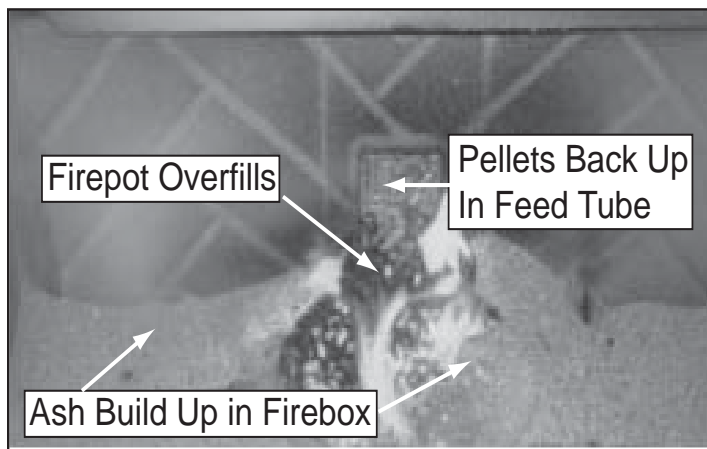

Figure 16.1

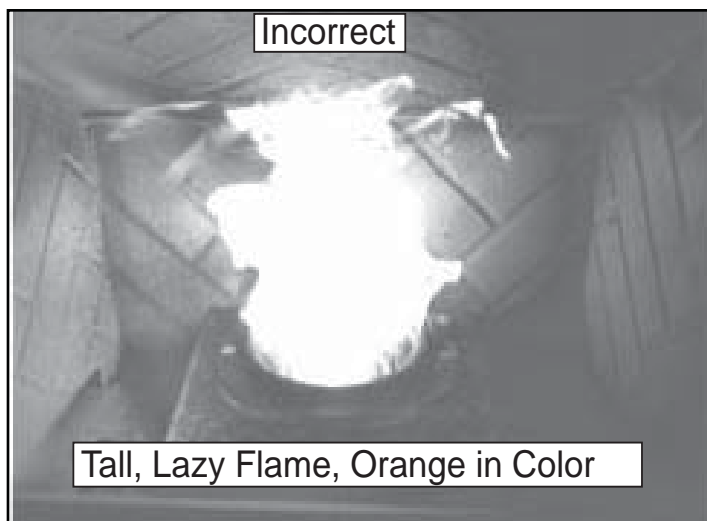

Figure 16.2

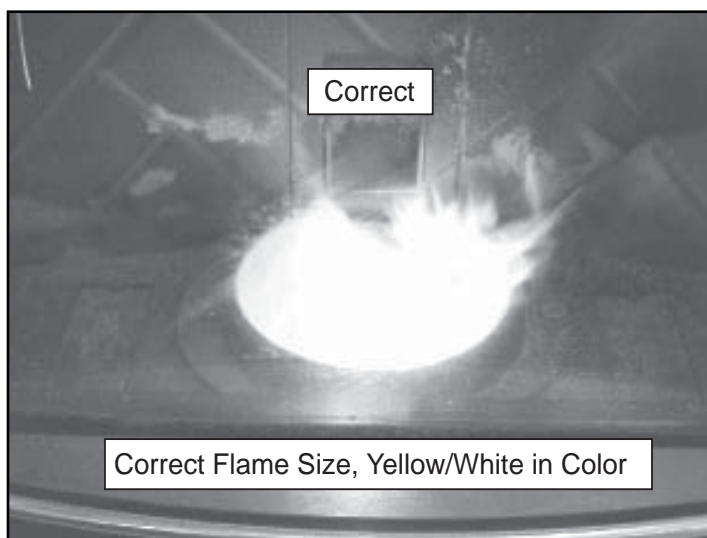

Figure 16.3

4 Troubleshooting Guide

With proper installation, operation, and maintenance your appliance will provide years of trouble-free service. If you do experience a problem, this troubleshooting guide will assist a qualified service person in the diagnosis of a problem and the corrective action to be taken. This troubleshooting guide can only be used by a qualified service technician.

Symptom	Possible Cause	Corrective Action
Plug in appliance - No response.	No current to outlet. 7 amp fuse defective. #3 snap disc tripped or defective. Control box defective.	Check circuit breaker at service panel. Replace fuse. Reset or replace snap disc. Replace control box.
Call light on. No fire. No fuel in firepot.	Out of fuel. #2 snap disc may be defective. Vacuum switch not closing, no vacuum. Control box defective.	Check hopper. Fill with fuel. Replace snap disc. Check exhaust blower is plugged in and operating. Check vacuum switch is plugged in. Check vacuum hose is in good condition, clear and connected at both ends. Check thermocouple is in good condition and plugged in properly. Make sure venting system is clean. Make sure front door is closed. Replace control box.
Call light on. No fire. Partially burned fuel in firepot.	Firepot clean-out plate not closed. Firepot is dirty (missed ignition).	Check that firepot clean-out plate is fully closed. Clean firepot. Make sure there is no clinker in the firepot. Clinkers may have to be broken up with firepot scraper tool or other means.
Call light on. No fire. Unburned pellets in firepot.	Firepot clean-out plate not closed. Firepot is dirty. Ignition hole blocked. Igniter not working. Control box defective.	Check that firepot clean-out plate is fully closed. Clean firepot. Make sure there is not a clinker in the firepot. Clinkers may have to be pushed out of firepot with firepot scraper tool or other means. Scrape with solid piece of wire. Remove ash pan to see if igniter is glowing red on start-up. Check igniter wires for good connection. Replace igniter using 1/4 inch male /female spade connectors. Replace control box.
Slow or smoky start-up.	Firepot clean-out plate not closed. Firepot is dirty. Excessive amount of fuel at start-up.	Check that firepot clean-out is fully closed. Clean firepot. Make sure there is not a clinker in the firepot. Clinkers may have to be pushed out of firepot with firepot scraper tool or other means. Reduce feed rate using feed rate adjustment control rod located inside hopper.

CASTILE FREESTANDING

Symptom	Possible Cause	Corrective Action
Slow or smoky start-up (Cont'd)	Dirty exhaust and/or venting system.	Check for ash build up in unit, including behind rear panels, firebox, heat exchanger, exhaust blower and venting.
Feed system fails to start.	Out of fuel. #2 snap disc may be defective. Vacuum switch not closing. No vacuum. Feed system jammed or blocked. Feed spring not turning with feed motor. Feed motor defective or not plugged in.	Check hopper, fill with fuel. Replace snap disc. Firebox door must be closed securely. Check exhaust blower is plugged in and operating. Check vacuum switch is plugged in. Check vacuum hose is in good condition, clear and connected at both ends. Check thermocouple is in good condition and plugged in properly. Make sure venting system is clean. NOTE: High winds blowing into the venting system can pressurize the firebox causing loss of vacuum. Empty hopper of fuel. Use a wet/dry vacuum cleaner to remove remaining fuel, from hopper, including feed tube. Check feed chute for obstructions. Loosen 2 feed assembly mounting screws and lightly shake feed assembly. Check that set screw is tight on feed spring shaft at end of feed motor. Check connections on feed motor, replace if defective.
No call light. Unit does not begin start sequence.	Thermostat not set to a high enough temperature. Snap Disc #3 tripped. No power. Fuse blown. Connections at thermostat and/or appliance not making proper contact. Defective thermostat or thermostat wiring. Control box defective.	Adjust thermostat above room temperature. Reset snap disc. Connect to power. Replace fuse. Check connections at thermostat and appliance. Replace thermostat or wiring. NOTE: To test thermostat and wiring, use a jumper wire at the thermostat block on the unit to by-pass thermostat and wiring. Replace control box.
Unit fails to shut off.	Call light on.	Turn thermostat off. If call light does not go out, disconnect thermostat wires from unit. If call light does go out, thermostat or wires are defective.

Symptoms	Possible Cause	Corrective Action
Convection blower fails to start.	#1 snap disc defective. Blower not plugged in. Blower is defective. Control box is defective.	Replace snap disc. Check that blower is plugged into wire harness. Replace blower. Replace control box.
Exhaust blower fails to start or does not shut off.	Blower not plugged in. Blower is clogged with ash. Blower is defective. Control box is defective.	Check that blower is plugged into wire harness. Clean exhaust system. Replace blower. Replace control box.
Large, lazy flame, orange color. Black ash on glass.	Dirty appliance. Poor fuel quality, high ash content. Firepot clean-out plate not completely closed. Excessive amount of fuel.	Clean unit, including firepot, heat exchangers and venting system. Remove stainless steel baffle from firebox to clean ash from on top of baffle. Clean behind rear brick panels. Change fuel brand to premium. Check that firepot clean-out plate is fully closed. Reduce feed rate using feed rate adjustment control rod located inside hopper.
Nuisance shutdowns.	Low flame. Sawdust buildup in hopper. Feed motor is reversing. Defective thermocouple. Defective control box. Firepot more than 1/2 full.	Increase feed by opening feed rate adjustment control rod located inside hopper. Clean hopper, see page 14. Check for good connections between feed motor and wire harness. Replace thermocouple. Replace control box. See page 16 for detailed instructions for "High Ash Fuel Content Management"
Appliance calls for heat. Call light illuminates. Exhaust blower starts. No feed or igniter.	Thermocouple is defective or not properly plugged in. Defective control box.	Check connections on thermocouple or replace if defective. A flashing yellow light on the control box indicates a problem with the thermocouple. Replace control box.

5 Service Parts Replacement

A. Glass Replacement - Door Assembly (Replace with 5mm ceramic glass only)

1. Open the face and remove door from the appliance by lifting door off of hinge pin and lay on a flat surface face down.
2. Using a screwdriver, tap the bottom of the rope retainer rod to push it up out of the hole. The top end of the rod will slide up. Swing the rod toward you from the bottom and remove the rod. Repeat for other side.
3. Remove old glass and replace with new glass.
4. Slide the retainer rod into the top hole first, and then line up the bottom crimped end with the hole in the door. The crimped end must be parallel with the glass in order to insert it into place. **Figure 20.1.**

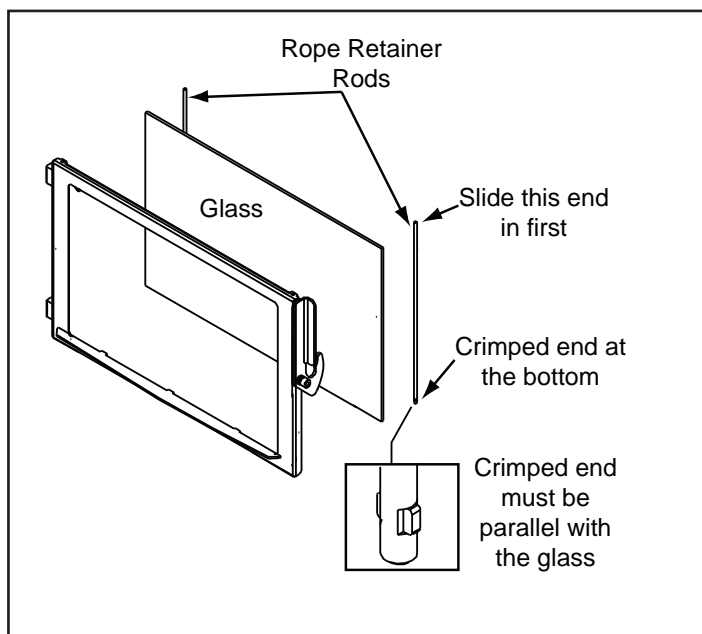

Figure 20.1

	WARNING
	<ul style="list-style-type: none"> • Glass is 5mm thick high temperature heat-resistant ceramic glass. • DO NOT REPLACE with any other material. • Alternate material may shatter and cause injury.

B. Igniter Replacement

1. Shut down the appliance by turning down the thermostat and let the appliance completely cool down. After the appliance has cooled down, unplug it and remove the ash drawer.
2. The wire leads to the igniter are connected to the wire harness with 1/4 inch male / female spade connectors. Disconnect the spade connections and remove the igniter from the chamber. Loosen thumb screw and slide igniter out.
3. Install new igniter into the chamber and tighten thumb screw. Re-connect the wires to the 2 leads with the spade connectors.
4. Double check that the igniter wires are clear of any movement, i.e. ash drawer, firepot cleaning rod, cleaning slide plates, etc.
5. Re-install the ash drawer and side panel and re-connect the power.

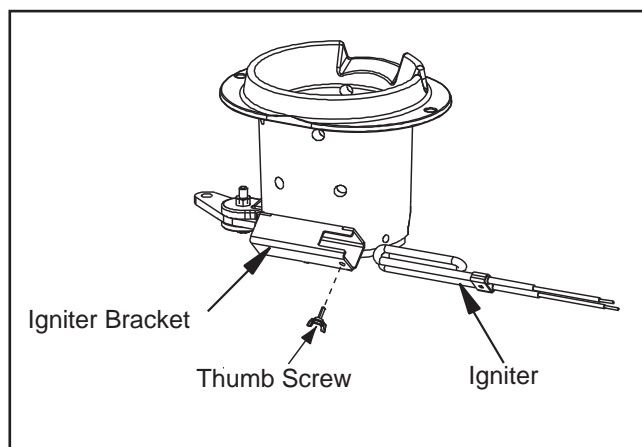

Figure 20.2

	CAUTION
	<p>Shock Risk.</p> <ul style="list-style-type: none"> • Do NOT remove grounding prong from plug. • Plug directly into properly grounded 3 prong receptacle. • Route cord away from appliance. • Do NOT route cord under or in front of appliance.

C. Blower Replacement

1. Convection Blower Replacement

NOTE: The convection blower must be removed before the exhaust blower can be removed.

- Turn down thermostat, let appliance completely cool and then unplug appliance before servicing.
- Remove both side curtains by loosening 2 screws (do not remove) and pull side panels away.
- Remove 4 screws from the back screen and pivot the top of the screen toward you leaving the bottom attached to stove. **Figure 21.1.**
- Remove 2 screws to remove the thermostat block and disconnect the 2 yellow wires.
- Remove the 2 screws from the power inlet and rotate it through the hole and out of the screen, leaving the wires attached.
- Disconnect the vacuum hose and both wires (orange and red) from the vacuum switch attached to the rear screen.
- Remove both wires from exhaust blower (blue and double white).
- Remove 6 screws using a flathead screwdriver or a 1/4" nut-driver. Retain screws for use on replacement blower. **Figure 21.2.**
- Remove exhaust blower and gasket.
- Install new gasket and blower. Discard blower housing if not needed.
- Re-install in reverse order.

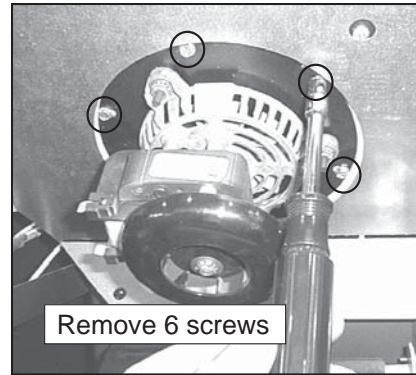

Figure 21.2

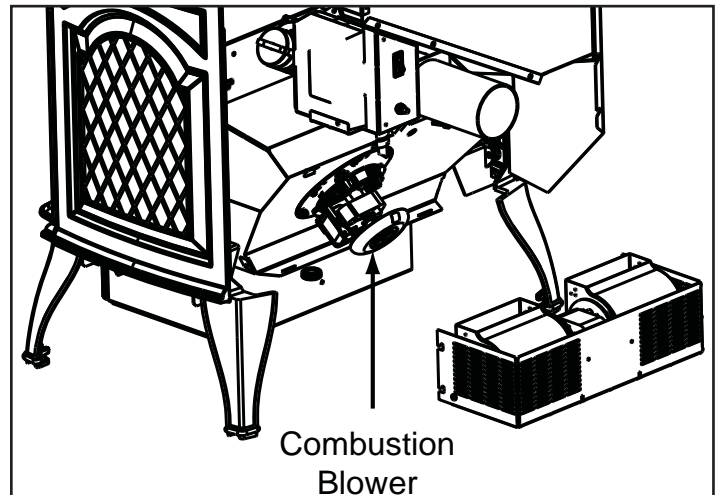

Figure 21.3

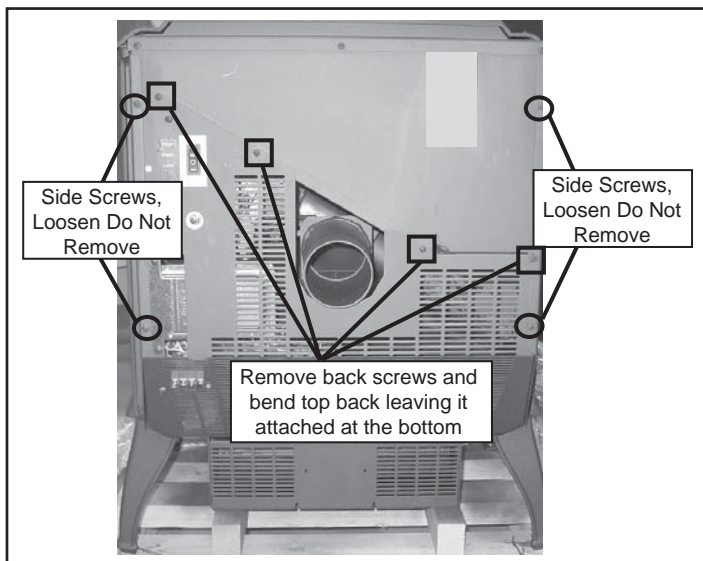

Figure 21.1

2. Combustion Blower Replacement

- Turn down thermostat, let appliance completely cool and then unplug appliance before servicing.
- The convection blower is located at the bottom rear of the appliance and is housed inside a screen box. Remove the 2 screws facing forward in the center of the blower chamber at the very back of the appliance.
- If an outside air kit is installed on the appliance, these screws attach the intake air channel piece of the outside air kit to the appliance. Remove the 2 screws and pull backwards on the channel and it will slide down and away from the appliance. The air channel, collar and outside air hose will be removed as one piece.
- There are 2 screws on each side of the housing. Loosen all 4 screws, but do not remove them. Lift the blower housing up slightly and slide towards you. **Figure 22.1 on page 22.**
- Remove the left side panel by loosening 2 screws (do not remove) and pull side panel away. Unplug the 2 black blower wires by disconnecting the spade connectors.

CASTILE FREESTANDING

- f. To remove blower from the housing, remove 2 screws in the front of the housing and very carefully bend the 2 housing sides out and bend the back of the housing away from the blower. This allows for room to access the back 2 screws and nuts (4 total) that is securing the blower to the housing.
- g. Remove blower and replace with new blower.
- e. Re-install in reverse order.

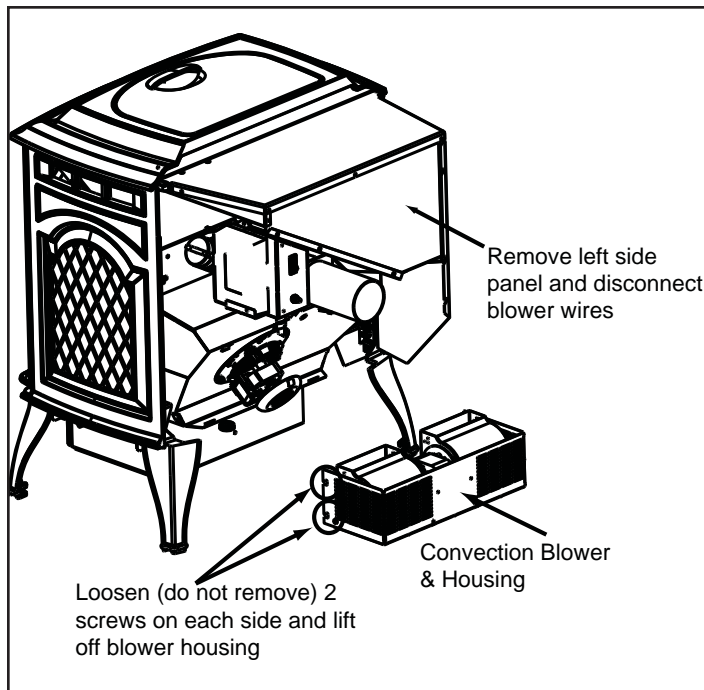

Figure 22.1

D. Baffle & Brick Set Removal

1. Follow proper shutdown procedures.
2. The top baffle has a hook on the bottom left side that rests on the top lip of the cast brick. There is a tab on the bottom right side that hooks into the side bracket. Remove the top baffle by first pulling the baffle forward until back edge drops down. Then slide baffle back until the front edge clears the shelf that it had been resting on.

Figure 22.2

3. The top baffle must be removed before you can remove the right and left brick. Remove the right brick by holding top lip of brick and lifting up, then push outside edge back. Slide brick to the right until it is flush with the firebox. Rotate the inside edge of the brick forward and remove brick. Repeat for left brick.

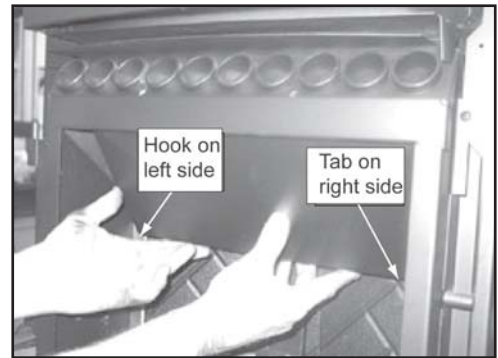

Figure 22.2

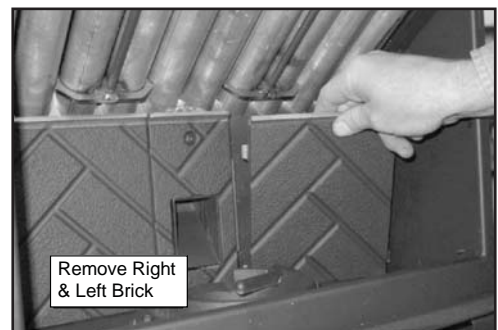

Figure 22.3

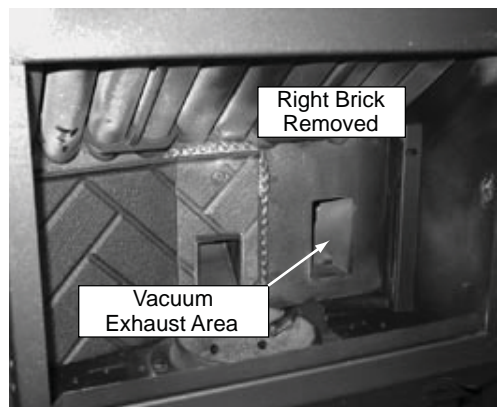

Figure 22.4

6 Reference Materials

A. Component Functions



When describing the location of a component, it is always **AS YOU FACE THE FRONT OF THE APPLIANCE**.

1. Control Box

- a. The control box is located on upper right side of appliance, behind the right side panel and above the vacuum switch.
- b. There is a light located inside of the control box. The internal light will turn green when the appliance has reached a temperature of 175°F (79°C) in the firepot. and will turn red when it reaches 600°F (315°C).
- c. There is also an internal blue light located in the upper left corner of the control box. When you plug in the appliance the blue light will automatically start blinking 6 times in a row for 60 seconds and then will stop.

NOTE:

Do **NOT** open the control box. This will void the warranty. If you need to plug in or remove the control box you must first **unplug the appliance**.

2. Convection Blower

The convection blower is mounted at the bottom rear of the appliance. There are 2 impellers, one on each side of the motor. The convection blower pushes heated air through the heat exchange system into the room.

3. Combustion Blower

The combustion blower is located on the right side of appliance and is designed to pull the exhaust from the appliance and push it out through the venting system.

4. Feed System

The feed system is located on the right side of the appliance and can be removed as an entire assembly. The assembly includes the feed motor, mounting bracket, bearing and feed spring (auger). The hollow feed spring (auger) pulls pellets up the feed tube from the hopper area and drops them down the feed chute into the firepot.

5. Firepot

The firepot is made of high quality ductile iron and has a cleaning pull-out rod. The floor of the firepot opens for cleaning when you pull out the rod. Be sure that the floor returns to a completely closed position or your appliance will not operate properly.

6. Fuse

The fuse is located on the front of the junction box on the right side of appliance. The fuse will blow should a short occur and shut off power to the appliance.

7. Heat Exchangers

The heat exchangers transfer hot air from the exhaust system into convection air. Remove the stainless steel top baffle to access the heat exchangers. There are 2 clean out rods located under the heat exchangers.

8. Heat Output Switch

The heat output switch is located on the upper right rear corner. The function of the heat output switch is to regulate the burn rates; low, medium and high settings.

9. Hopper Switch

The hopper switch is located in the upper right hand corner of the hopper. This switch is designed to shut down the feed motor whenever the hopper lid is opened.

10. Igniter

The igniter is mounted on the base of the firepot. Combustion air travels over the red hot igniter creating super heated air that ignites the pellets.

11. Junction Box And Wiring Harness

The junction box is located on the right side of the appliance, behind the right side panel. The junction box and wiring harness are replaced as one component.

12. Power Supply

The power outlet is located on the lower right side of the appliance on the front of the junction box. Check the wall receptacle for 120 volt, 60 Hz (standard current). Make sure the outlet is grounded and has the correct polarity. A good surge protector is recommended. When operating with a generator you need a least 600 watts of power, or with an inverter at least 800 watts of power available for the appliance during the start cycle.

13. Red Call Light

The red call light is on the front of the junction box, behind the control box. The function of the red call light is to indicate that the thermostat is calling for heat.

14. Reset Button

The reset button is located on the back of the appliance on the upper right corner of the side panel under the heat output control switch. The function of the button is to momentarily open the thermostat circuit, which restarts the system.

15. Thermocouple

The thermocouple is located on top of the firepot inside the thermocouple cover (ceramic protection tube). The thermocouple sends a millivolt signal to the control box indicating the preset temperatures of the green and red lights have been obtained.

16. Thermostat

The appliance is designed to run on a 5 volt DC thermostat. The heat anticipator should be set on the lowest setting available.

CASTILE FREESTANDING

17. Snap Disc #1 (Convection Blower) 110°F

Snap disc #1 is located on the right side of the appliance on the top of the heat exchanger box. There are 2 purple wires connected to it. This snap disc turns the convection blower on and off as needed. Power is always present at snap disc #1.

18. Snap Disc #2 (Fuel Delivery Interrupt) 250°F

Snap disc #2 is also located on the back side of the feed drop tube. There are 2 orange wires connected to it. This snap disc will turn off the feed system which will turn off the appliance if an overfire condition should occur or if the convection blower should fail to operate. If this occurs the snap disc will automatically reset itself.

19. Snap Disc #3 (Back Burn Protector) 250°F

Snap disc #3 is mounted on the back of the auger tube in the center of the appliance and has a red reset button. To

access it remove the right side panel. If the fire tries to burn back into the feed system or push exhaust up the feed tube, this snap disc will shut the entire system off. This disc must be manually reset.

20. Vacuum Switch

The vacuum switch is located on the right side of the appliance behind right side panel. This switch turns the feed system on when vacuum is present in the firebox. The vacuum switch is a safety device to shut off the feed motor if the exhaust or the heat exchanger system is dirty or plugged or if the firebox door is open.

21. Wiring Harness

See Figure 24.1 below.

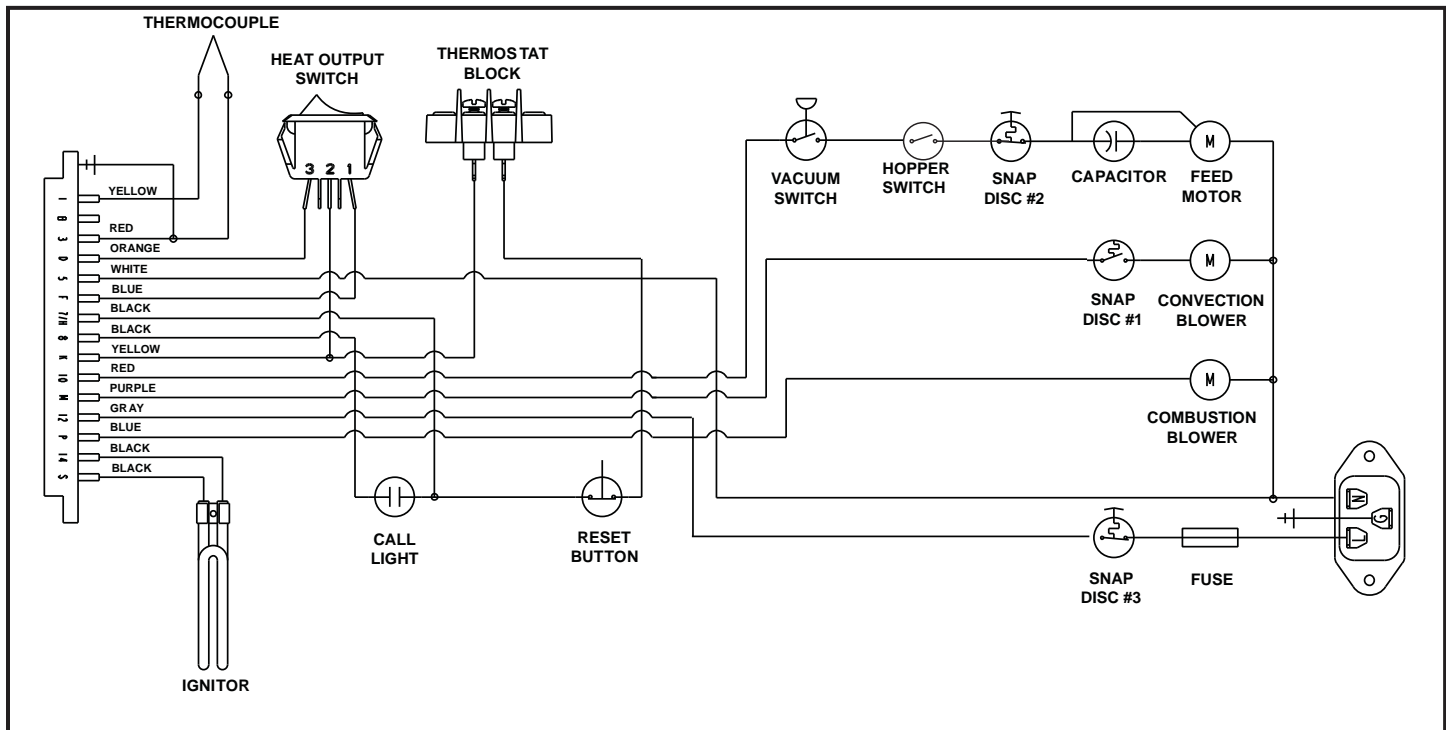

Figure 24.1

B. Component Locations

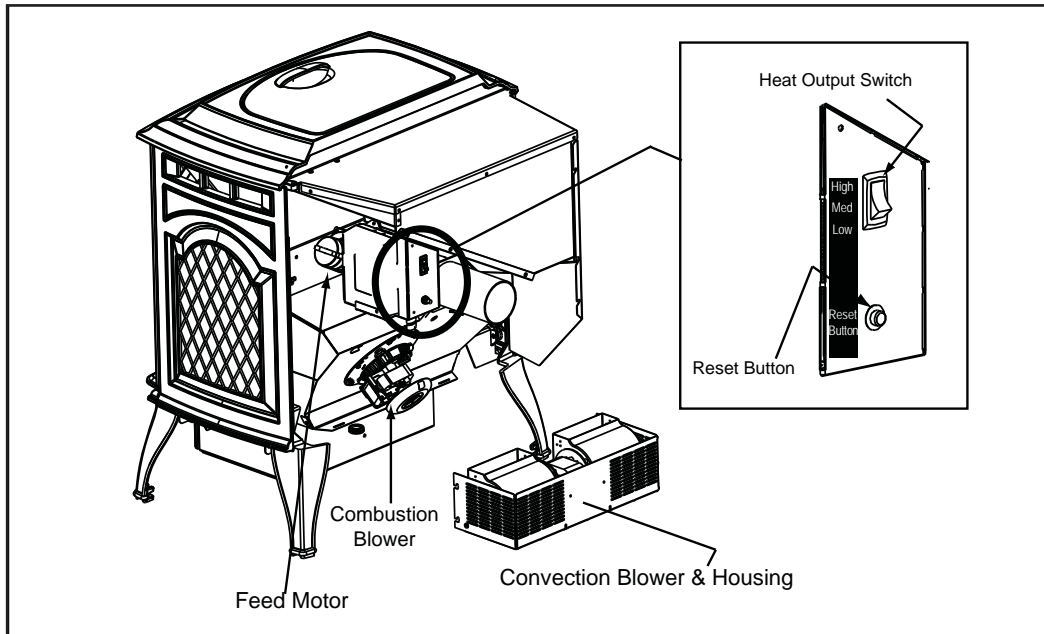

Figure 25.1

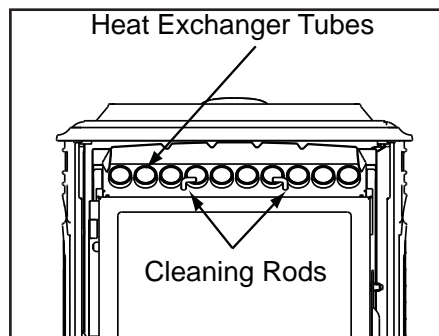

Figure 25.2

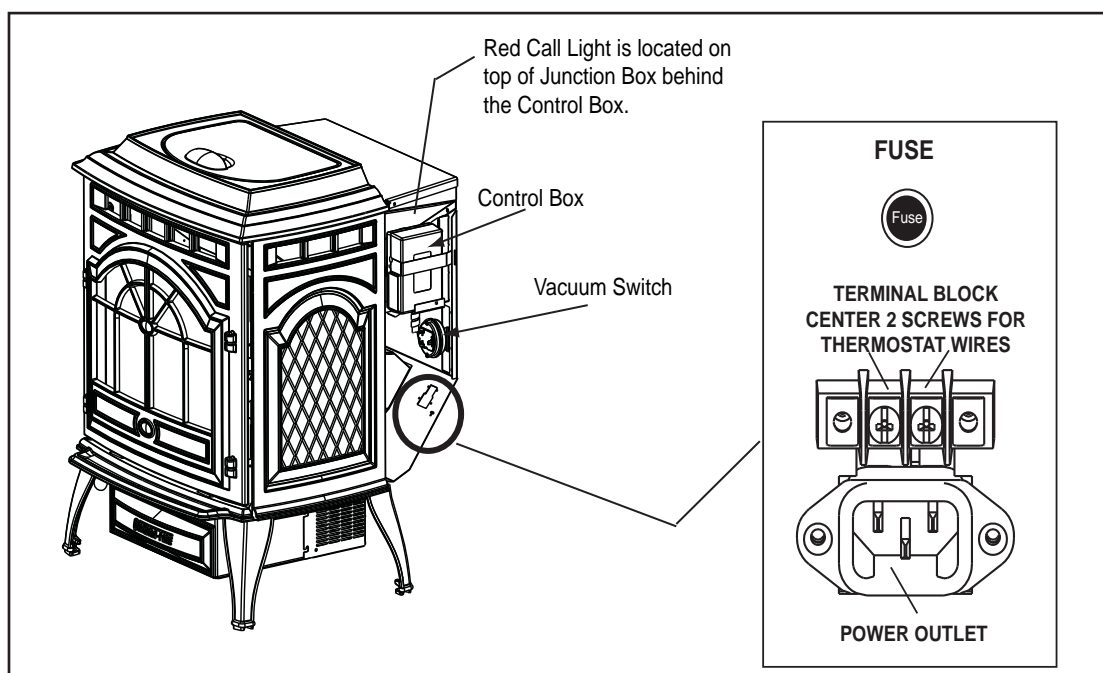
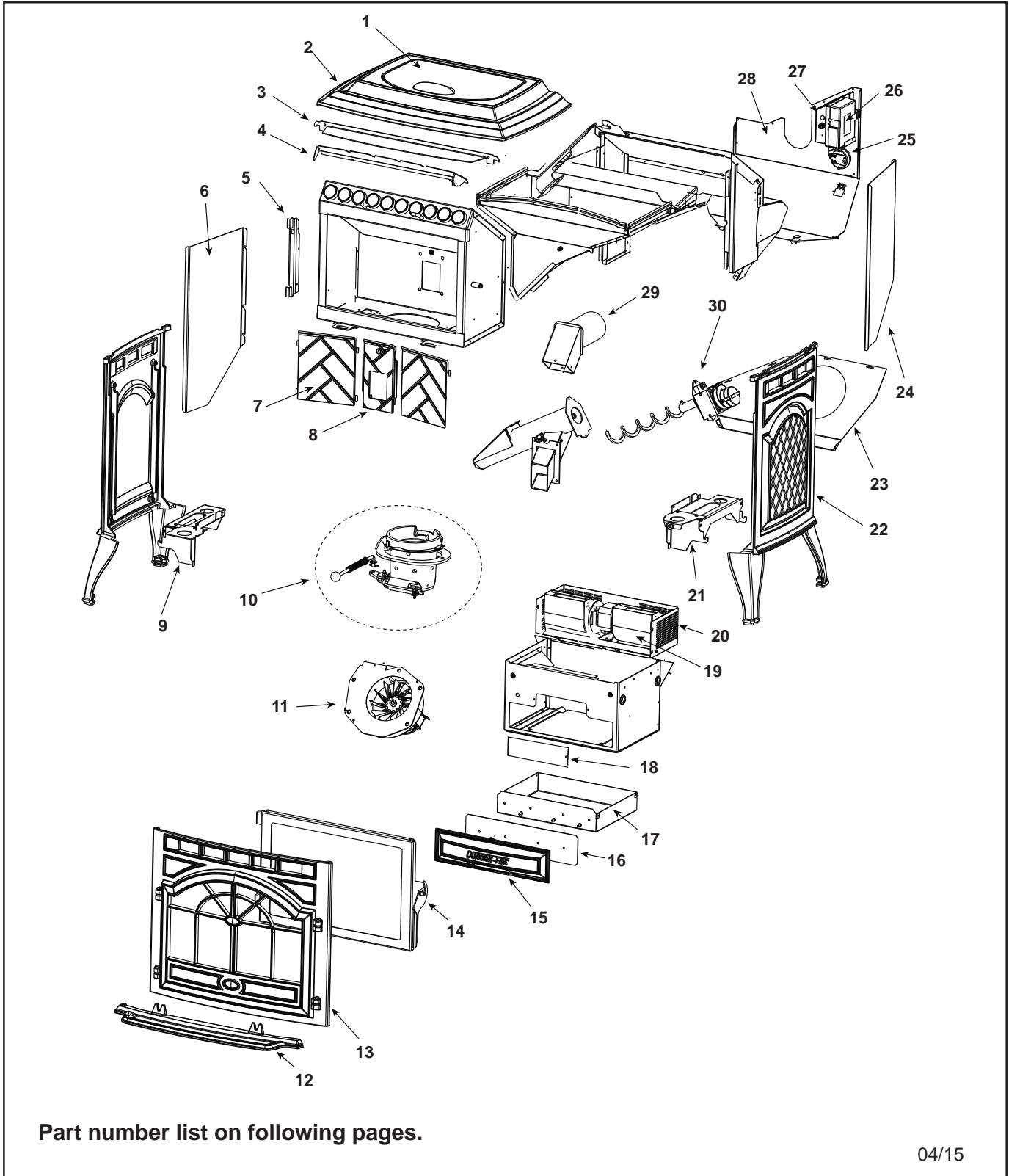

Figure 25.3

CASTILE-CSB-B, , CASTILE-MBK-B, CASTILE-PMH-B
CASTILE-CWL-B (Oct 2009 thru June 2011)



Part number list on following pages.

Beginning Manufacturing Date: Oct. 2009
Ending Manufacturing Date: Active

D. Service Parts

IMPORTANT: THIS IS DATED INFORMATION. Parts must be ordered from a dealer or distributor. **Hearth and Home Technologies does not sell directly to consumers.** Provide model number and serial number when requesting service parts from your dealer or distributor.



Stocked at Depot

ITEM	DESCRIPTION	COMMENTS	PART NUMBER	
1	Hopper Lid Assembly	Black	SRV7021-022MBK	
		Mahogany	SRV7021-022PMH	
		Sienna Bronze	SRV7021-022CSB	
		Willow	SRV7021-022CWL	
	Bumper, Rubber	Pkg of 12	SRV224-0340/12	Y
	Magnet Round		SRV7000-140	Y
2	Top	Black	7021-101MBK	
		Mahogany	7021-101PMH	
		Sienna Bronze	7021-101CSB	
		Willow	7021-101CWL	
3	Cast Retainer Upper		SRV7021-141	
4	Convection Air Director		SRV7021-123	
5	Hinge Bracket		SRV7021-115	
6	Outer Skin Left		SRV7021-119	
7	Brick, Left / Right, Cast		414-0270	
8	Brick, Center, Cast		414-0260	
9	Cast Retainer Lower Left Assembly		SRV7021-018	

#10 Firepot Assembly and Associated Parts

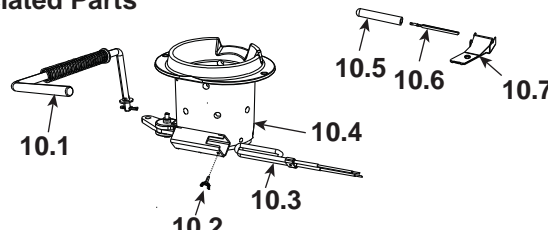

10.1	Pull Rod Assembly		SRV7021-005	
	Knob, Ash Dump Control Rod		832-3020	
	Spring, Firepot		200-2050	
10.2	Wing Thumb Screw 8-32 x 1/2	Pkg of 24	7000-223/24	Y
10.3	Heating Element Assembly 18" (Loop Igniter)	Pkg of 10	SRV7000-462/10	Y
10.4	Firepot Assembly		SRV414-5200	Y
	Bushing, Firepot		410-8320	Y
	Floor, Firepot		414-0290	Y
	Gasket, Firepot		240-0930	Y
	Nut, Lock 1/4-20	Pkg of 25	226-0090/25	Y
	Bolt, Firepot, 1-1/4" Long	Pkg of 25	225-0120/25	Y
10.5	Thermocouple Cover	Pkg of 10	812-4920	Y
10.6	Thermocouple		812-4470	Y
10.7	Thermocouple Clamp		SRV7001-203	Y

IMPORTANT: THIS IS DATED INFORMATION. Parts must be ordered from a dealer or distributor. **Hearth and Home Technologies does not sell directly to consumers.** Provide model number and serial number when requesting service parts from your dealer or distributor.



Stocked at Depot

ITEM	DESCRIPTION	COMMENTS	PART NUMBER	
11	Exhaust Combustion Blower, 45 CFM		812-4400	Y
	Gasket, Exhaust Combustion Blower (between...)	...Housing & Stove	240-0812	Y
		...Motor & Housing	812-4710	Y
12	Ashcatcher - Must specify color	Black	413-0010BK	
		Porcelain Color	413-0010POR	
		Powder Coat	413-0010PWD	
13	Face	Black	413-0030BK	
		Porcelain Color	413-0030POR	
		Powder Coat	413-0030PWD	

#14 Door Assembly

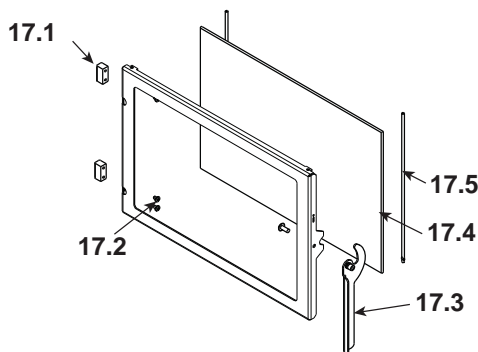

14	Door Assembly		SRV7021-007	
14.1	Hinge, Female		450-2910	
14.2	Door Frame		SRV7021-114	
	Gasket, Tadpole, 3/8	10 ft.	842-5130	Y
14.3	Screw, Pan Head Philips, 10/32 x 1/4	Pkg of 24	229-1230/24	Y
14.4	Screw, Machine Screw 1/4-20 x 5/8	Pkg of 24	220-0440/24	Y
14.5	Door Latch Assembly		7021-006	
14.6	Glass Assembly (w/gasket) 17-1/4" W x 11-5/8" H		7001-038	Y
14.7	Retainer, Rope		7001-192	Y
	Tape, 1/2" X 1/16, 10 Ft	10 ft.	240-0290/10	Y
	Tape, Door Corner	1 ft.	SRV7027-227	Y
15	Ash Drawer Front		SRV7021-138	
16	Ash Drawer Gasket		SRV7021-139	
17	Ash Drawer		SRV7021-140	
18	Igniter Access Plate		SRV413-0380	
19	Convection Blower, 150 CFM		812-4900	Y
20	Shroud, Convection Blower		SRV413-0300	
21	Cast Retainer Lower Right Assembly		SRV7021-021	

IMPORTANT: THIS IS DATED INFORMATION. Parts must be ordered from a dealer or distributor. **Hearth and Home Technologies does not sell directly to consumers.** Provide model number and serial number when requesting service parts from your dealer or distributor.



Stocked at Depot

ITEM	DESCRIPTION	COMMENTS	PART NUMBER	
	Ash Drawer Assembly - w/Door, Gasket, Ashpan		SRV7021-020	
	Baffle Assembly		7001-034	Y
	Bracket, Snap Disc		7005-253	
	Component Pack Assembly (Includes Firepot Cleanout Tool, Touch-Up Paint, Power Cord & Wiring Harnes To The Thermostat, 2 Leveling Nuts & Screws, Owners Manual, Warranty Card, "How-To-Operate" Dvd)	Black	SRV7021-011	
		Mahogany	SRV7021-017	
		Sienna Bronze	SRV7021-016	
		Willow	SRV7021-015	
	Cleanout Tool		414-1140	Y
	Dvd Original Energy Stove		7000-440	
	Harness, Thermostat Wire		230-0810	
	Leveling Assembly		7000-000	
	Paint Touch-Up, 4 Oz	Matte Black	812-0910	
		Mahogany	855-1450	
		Sienna Bronze	TOUCHUP-CSB	
		Willow	TOUCHUP-CWL	
	Power Cord		812-1180	Y
	Deflector, Bottom Airwash		413-0680	
	Feed Adjustment Plate		7001-182	
	Fuse, 7 Amp	Pkg of 10	812-0380/10	Y
	Fuse, (for control Box)	Pkg of 10	812-3780/10	Y
	Gasket, Hopper, Front/Back		SRV7021-147	
	Hinge, Door, Male		450-2810	
	Hopper Lid Switch Assembly		SRV7021-023	Y
	Hopper Lid Magnetic Switch		7000-375	Y
	Hopper Top		SRV7021-108	
	Hose, Vacuum, 5/32 Id	3 Ft.	SRV240-0450	Y
	Log Set (Optional)		LOGS-30-OE	
	Log, Left Rear		7050-144	
	Log, Right Rear		7050-143	
	Magnet Bracket		SRV7021-129	
	Plate, Ash Cleanout		7001-186	
	Reset Button Assembly		SRV7000-040	
	Scraper Repair Kit		SCRAPER-CSTL	
	Snap Disc	Manual Reset	SRV230-1290	Y
	Snap Disc, 110-20		SRV230-1220	Y
	Snap Disc # 2	On Droptube	SRV7000-268	Y
	Wire Harness Hopper Switch		SRV7050-130	Y

E. Homeowner Notes

QUADRA-FIRE®

NOTHING BURNS LIKE A QUAD

CONTACT INFORMATION

Hearth & Home Technologies
1445 North Highway
Colville, WA 99114
Division of HNI INDUSTRIES

Please contact your Quadra-Fire dealer with any questions or concerns.
For the number of your nearest Quadra-Fire dealer
log onto www.quadrafire.com

CAUTION

DO NOT DISCARD THIS MANUAL



- Important operating and maintenance instructions included.
- Read, understand and follow these instructions for safe installation and operation.
- Leave this manual with party responsible for use and operation.

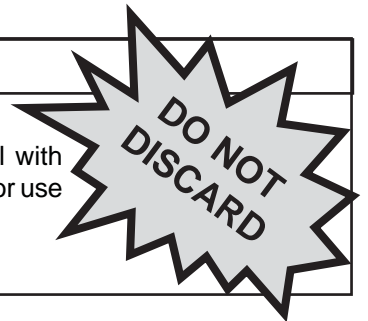

We recommend that you record the following pertinent information for your heating appliance.

Date purchased/installed: _____

Serial Number: _____ Location on appliance: _____

Dealership purchased from: _____ Dealer phone: _____

Notes: _____

This product may be covered by one or more of the following patents: (United States) 5341794, 5263471, 6688302, 7216645, 7047962 or other U.S. and foreign patents pending.